

Article number: 201748149

Description: E+G Latch clamp with trigger function
GN 854-1500-2-T2S

Measures

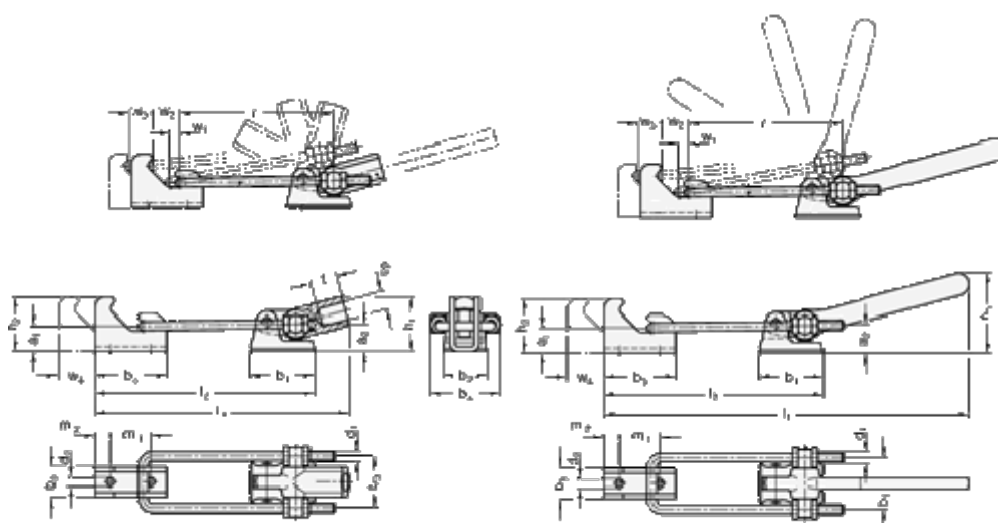

a1 = 26	d1	= M10	m1 = 40	w4 = 40
a2 = 28	d2	= 8.5	m2 = 16	
b1 = 65	d3	= 18	r = 120	
b2 = 43	h1	= 55	Size = 1500	
b3 = 52	h2	= 55	t = 30	
b4 = 70	Holding force N	= 13000	w1 = 11	
b5 = 72	l1	= 220	w2 = 28	
b6 = 30	l2	= 186	w3 = 25	